

SUPERNATE

DESIGN BY
JONAS WAGELL

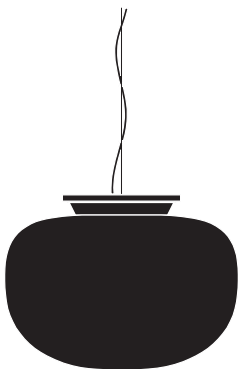

FRANDSEN

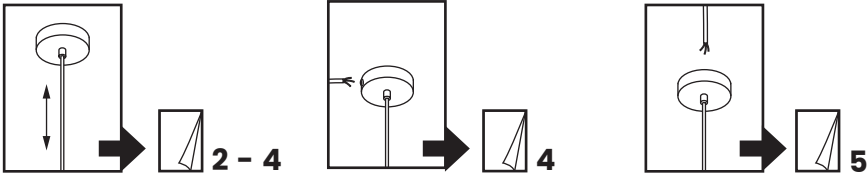

DK - SIKKERHEDSFORANSTALTNINGER

Hvis lampens udvendige ledning bliver beskadiget skal der, for at undgå en farlig situation, rettes henvendelse til producenten, service agenten eller anden lignende kvalificeret person for udskiftning af denne.

UK - SAFETY PRECAUTIONS

If the external flexible cable or cord of this luminaire is damaged, it shall be exclusively replaced by the manufacturer or his service agent or a similar qualified person in order to avoid a hazard.

F - PRÉCAUTIONS DE SÉCURITÉ

Si le câble ou le cordon flexible externe de ce luminaire est endommagé, il doit être remplacé exclusivement par le fabricant, son agent de service ou une personne qualifiée similaire afin d'éviter tout danger.

E - MEDIDAS DE SEGURIDAD

Si el cable externo o cordón de esta luminaria es dañado, deberá ser reemplazado exclusivamente por el fabricante, su agente comercial o persona cualificada similar para evitar cualquier peligro.

D - SICHERHEITSVORKEHRUNGEN

Wenn das äußere flexible Kabel oder die Schnur dieser Leuchte beschädigt ist, darf nur der Hersteller oder sein Kundendienst oder eine ähnlich qualifizierte Person das Kabel ersetzen, um eine Gefährdung zu vermeiden.

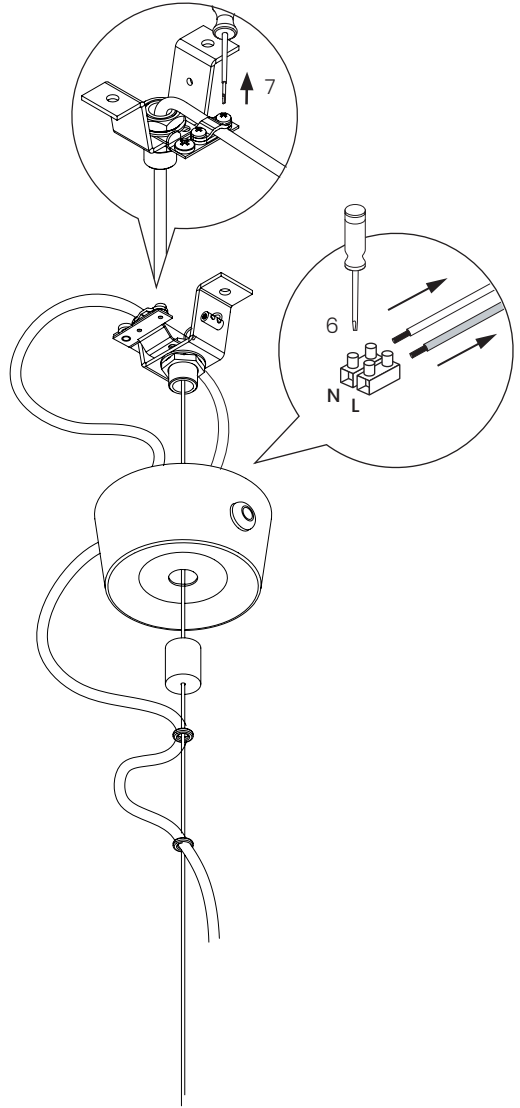
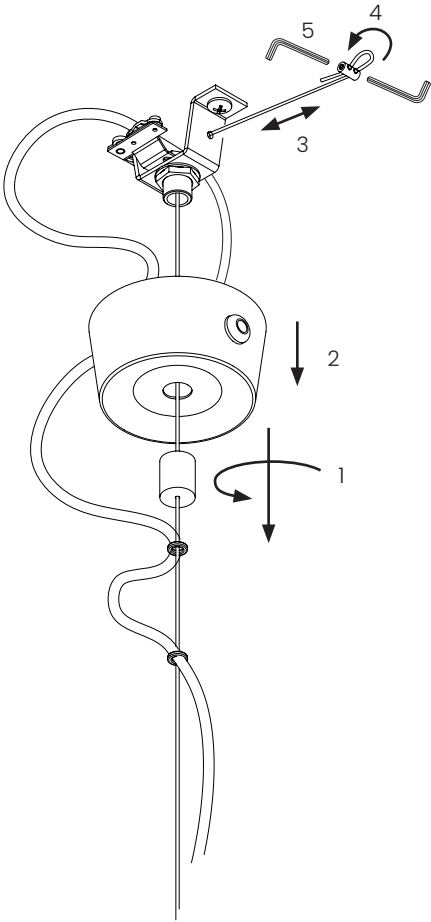
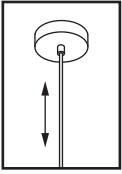

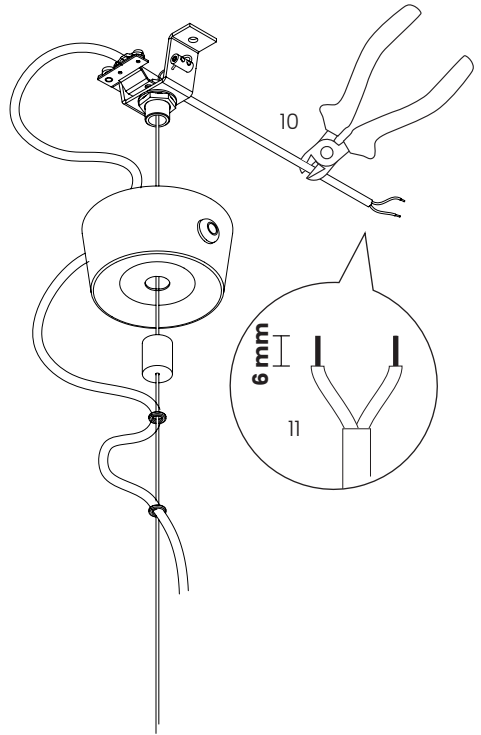
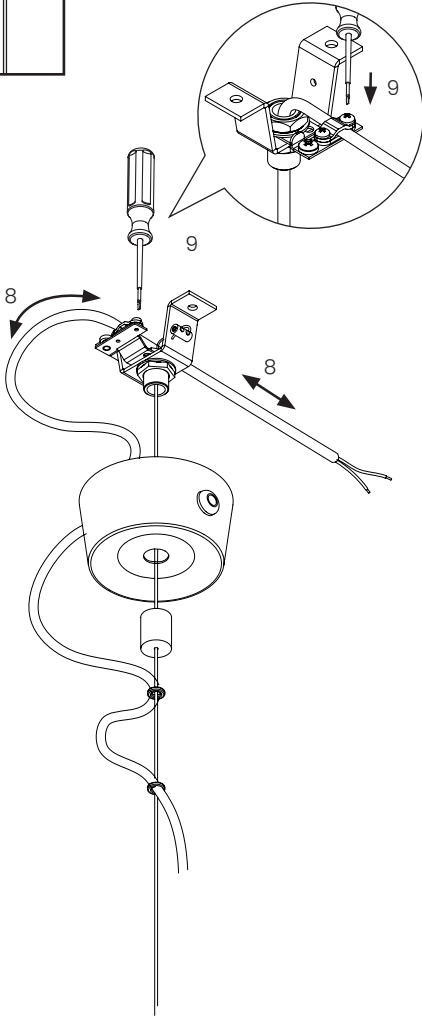
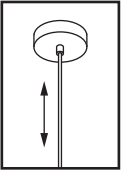

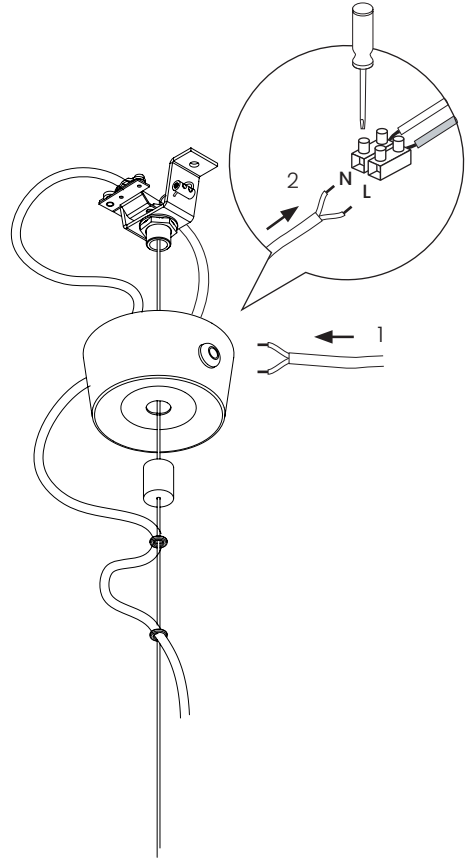
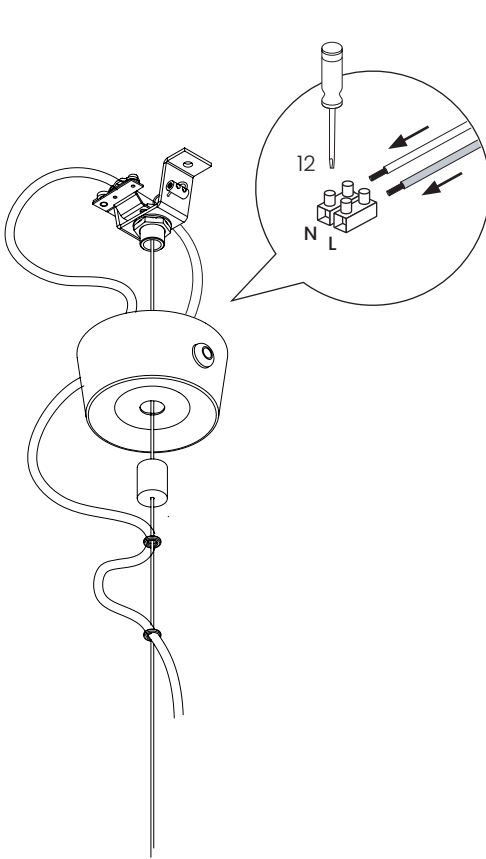
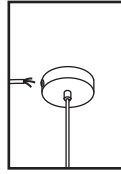
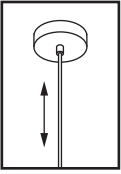

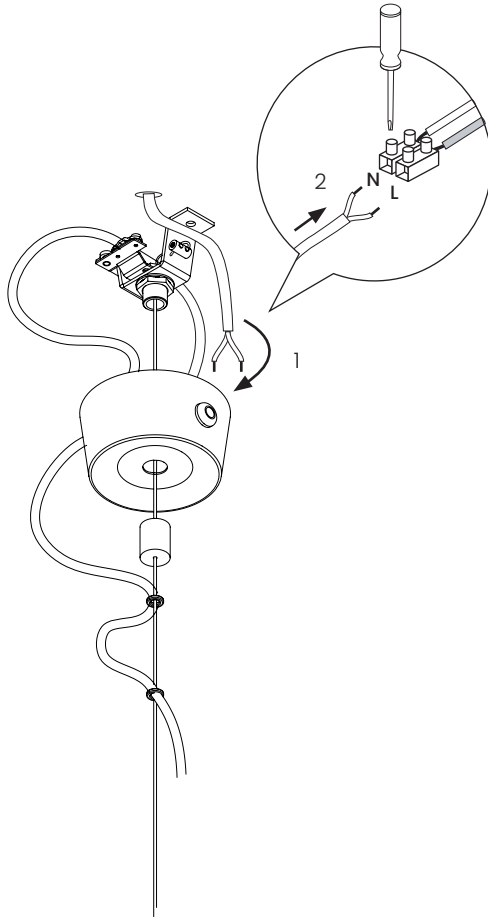
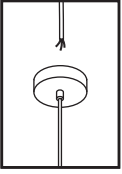



Recommended light bulb:

Philips CorePro LED bulb

E27

8,5 W

806 lm

2700 K

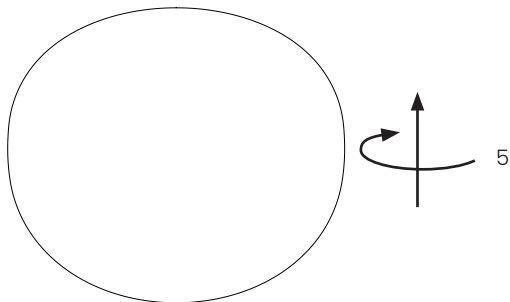
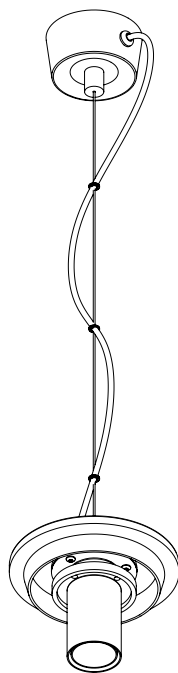
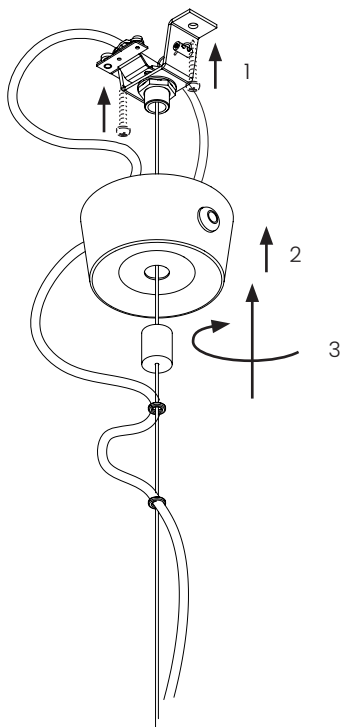

FRANSEN