

Reeds

design
Klaus Begasse

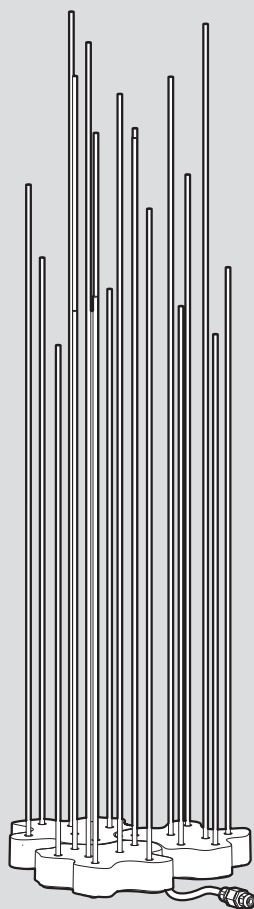

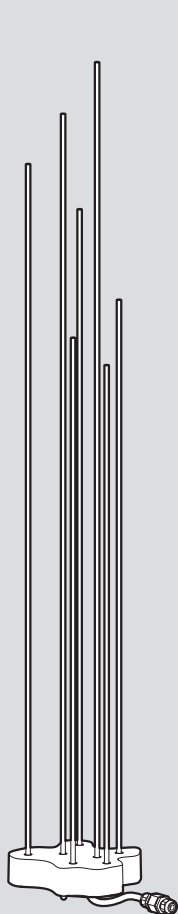

i

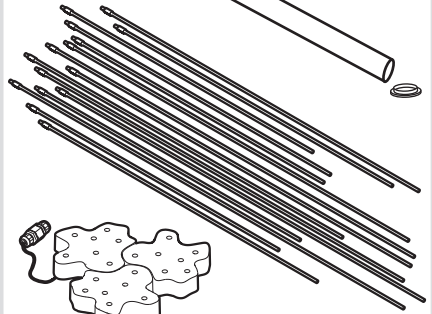
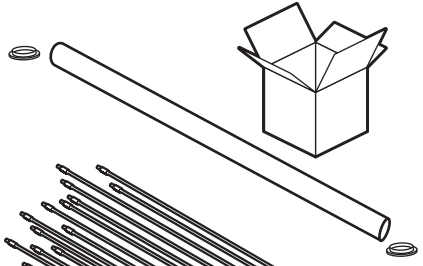
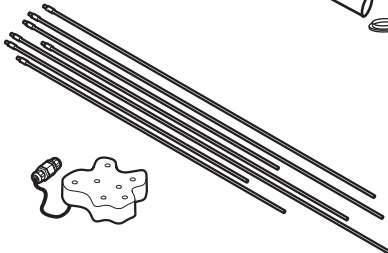
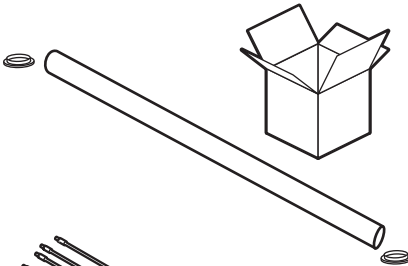
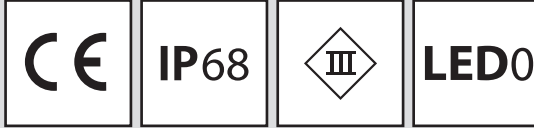

i

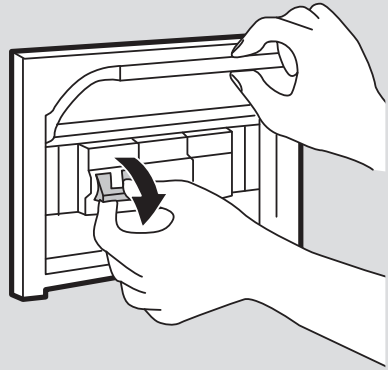
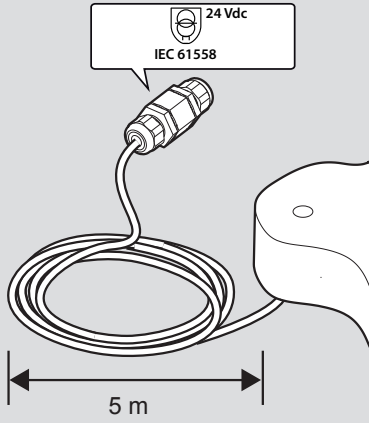

1

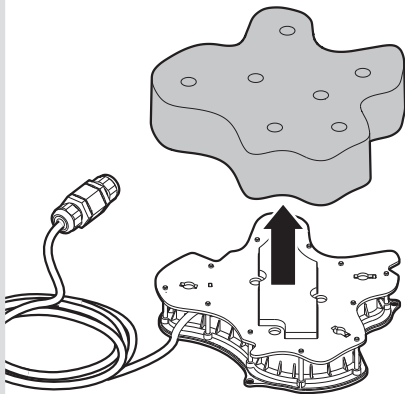

2

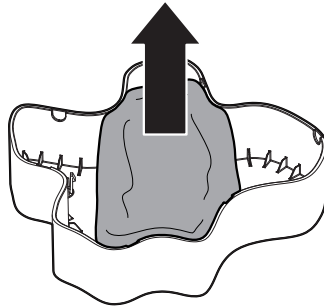

3

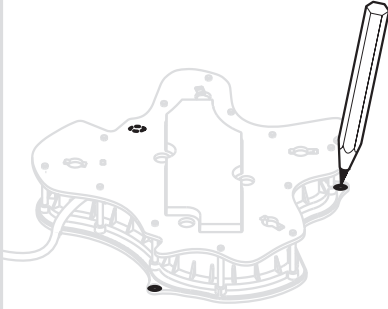

4

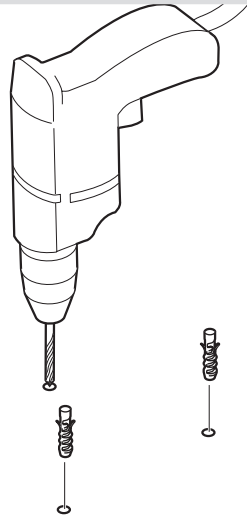

5a

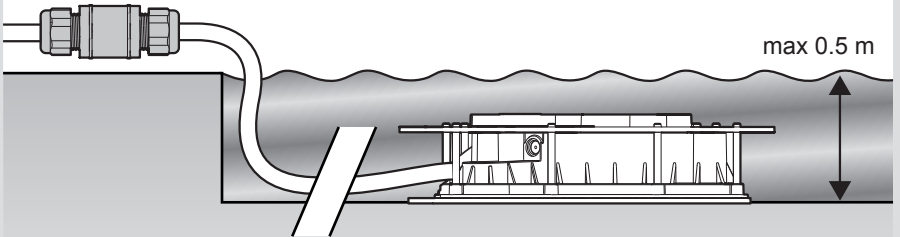

5b

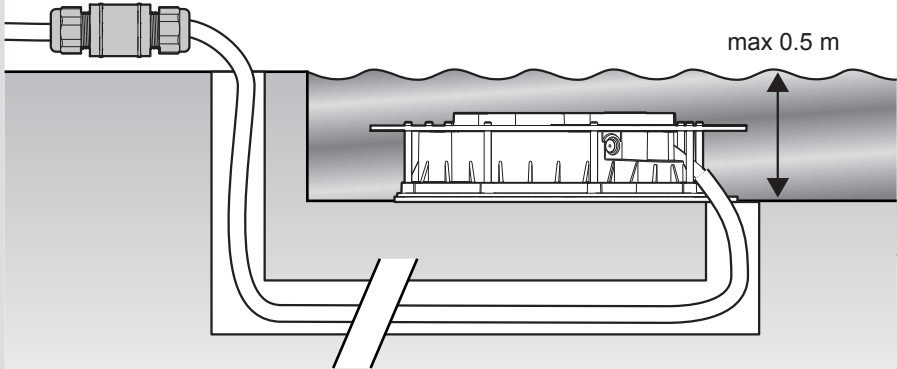

6

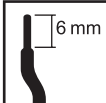
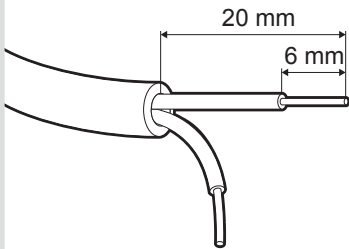

7

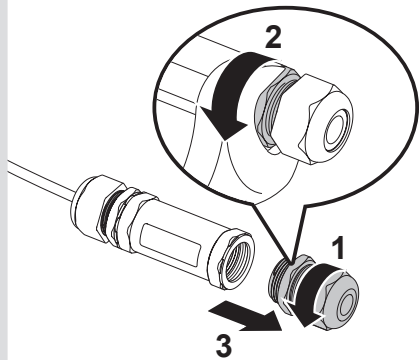

8

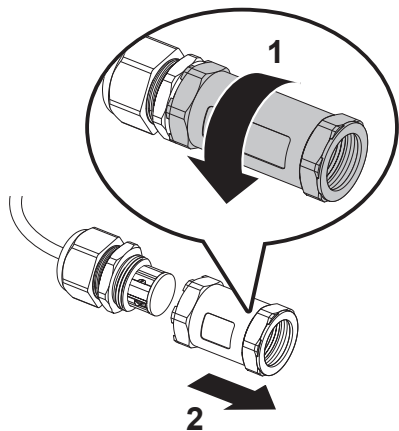

9

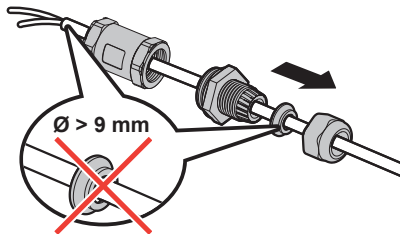

10

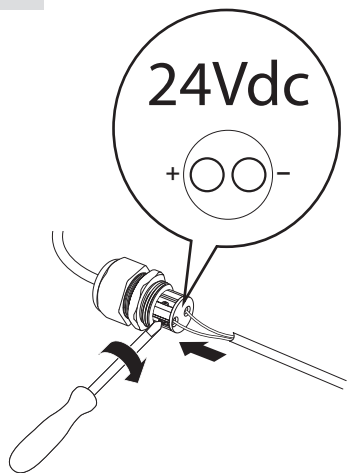

11

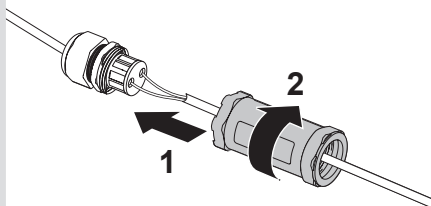

12

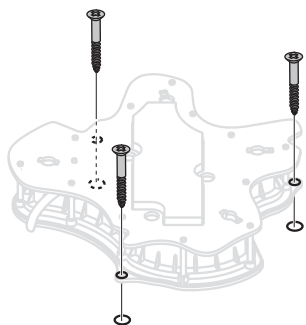

13

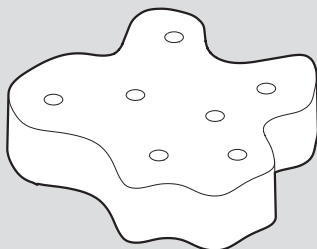
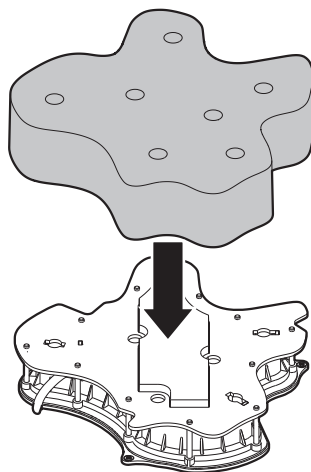

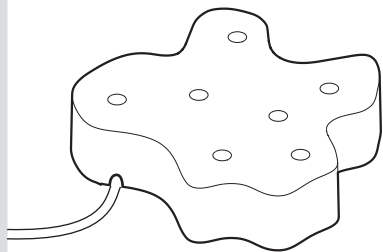

i



i

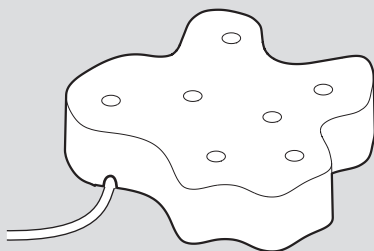
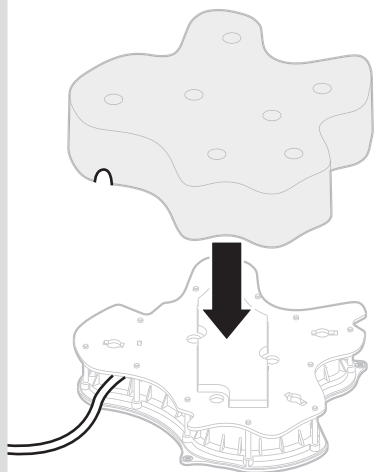

14

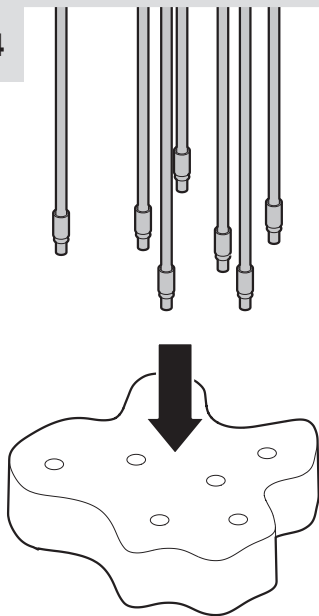

15

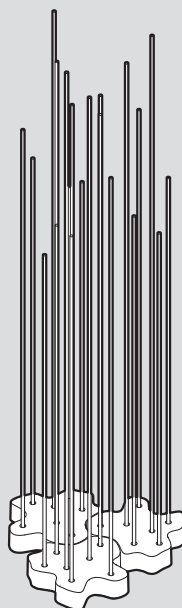
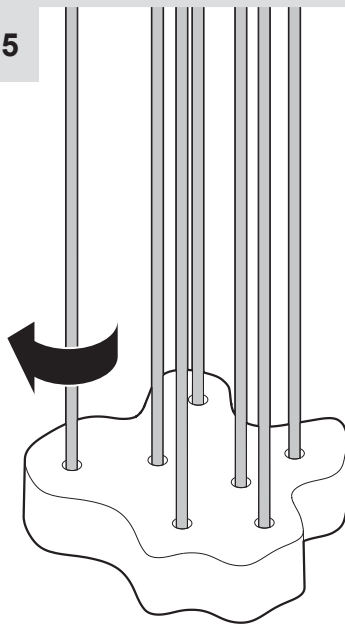



i



1

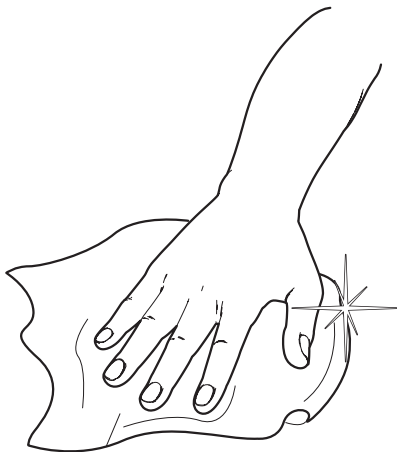

Artemide®

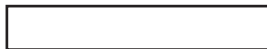

Artemide

via Bergamo, 18
20010 Pregnana M.se (MI)
ITALIA

tel. +39 02 935 181
fax +39 02 935 90 254
fax +39 02 935 90 496

www.artemide.com

VAT IT00846890150

cod. Y513000152D