









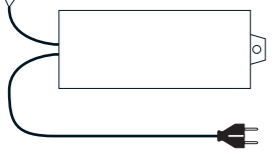
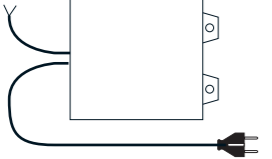
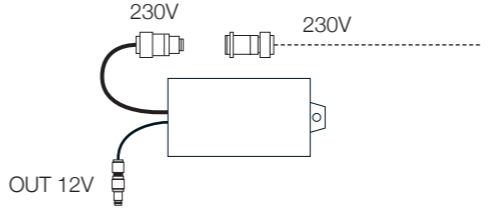
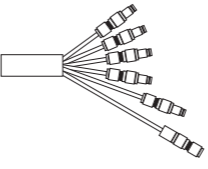

OUTDOOR: GEL BOX SYSTEM

	MB1 Mini gel box IP68
	5,3x3,9x2,4 cm
	(max 2 connections - connectors included)
	MB2 Mini gel box IP68
	5,2x5,3x2,9 cm
	(max 6 connections - connectors included)
	KP1 Extension cord kit
	5 mt
	with mini gel box IP68 for single connection
	(max 1 lamp)
	ED6 Driver 10W 12V DC 220-240V IP67
	7x3,7x2,3 cm / cables 45 cm ca.
	not dimmable
	(max 6 lamps)
	ED7 Driver 30W 12V DC 220-240V IP67
	11x3,7x2,3 cm / cable 12V 45 cm ca. / plug cable 200 cm
	not dimmable
	(max 20 lamps)
	ED7D Driver 30W 12V DC 220-240V IP67
	8x8x3 cm / cables 12V 45 cm ca. / plug cable 200 cm
	Triac dimmable
	(max 20 lamps)

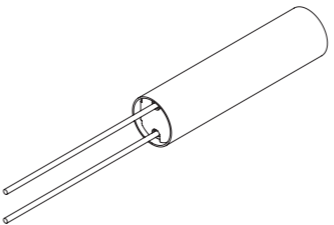
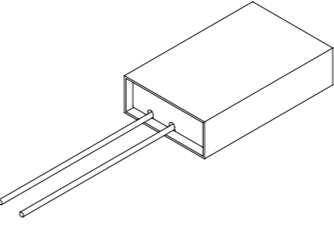
OUTDOOR: QUICK CONNECTORS SYSTEM

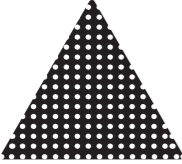
	ED6CR Driver 10W 12V DC 220-240V IP67 /
	230V and 12V connectors included
	3,7x2,3x7 cm - cables 45 cm ca.
	not dimmable
	CRM Quick IP68 multiple connector / 1 IN & 5 OUT 12V
	(max 5 connections)
	CRS Quick IP68 IN single connector
	KP2 Extension cord kit with quick IP68 connectors CRS
	5 mt
	(max 1 lamp)
	FKIPL Kit box driver
	Ø 5x20 cm / cable 12V 45 cm / plug cable 200 cm
	not dimmable (driver ED7)
	standard
	FKIPLD Kit box driver
	16x10x4 cm / cable 12V 45 cm / plug cable 200 cm
	Triac dimmable (driver ED7D)
	available on request

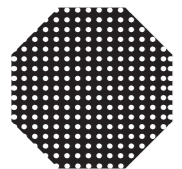
OUTDOOR ACCESSORIES

	MSMP	Supporting modular plate
		for More (MR70/MR100/MR130)
		32x32x32 cm
		(max 4 lamps)
	MPT	Peg
		for More (MR70/MR100/MR130)
		25 cm
	MSM	Supporting plate
		for Medousê F
		31x31 cm ca.
	MDCV	Plug cable 230V standard EU (CH available on request)
		for Medousê F
		350 cm

MEDOUSÊ INSTALLATION SUGGESTIONS

WARNING

For stability reasons the lamp must be fastened to a solid surface such as a well or basement; in alternative it can be mounted on the modular supporting plate (ref. L / code MSM) available on request. Before installing the lamp, please check the levelling of the soil and make sure that it can support the weight of the fitting.

(Medousê weight Ø 30 cm 15 kg / Ø 50 cm 31 kg)

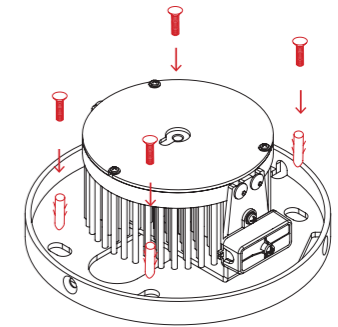

lamp base with holes for the fastening (plugs not included)

Example 1

with basement and supply cable from the side

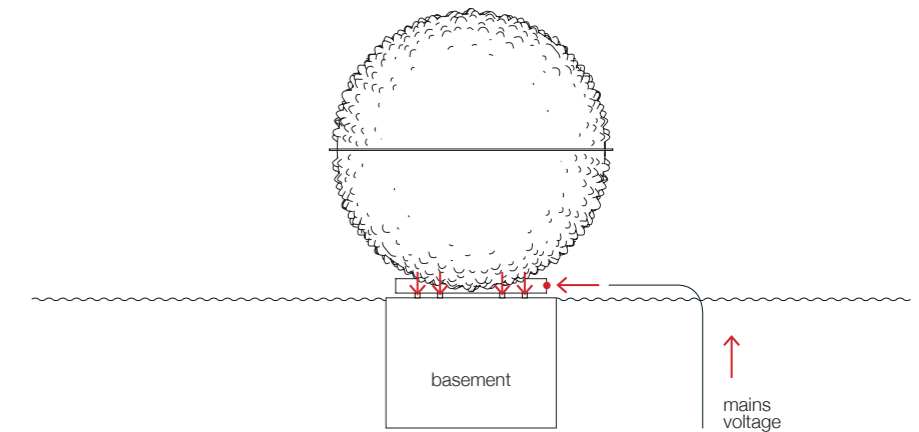
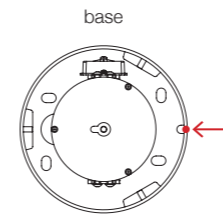

Example 2

with well and supply cable from underneath

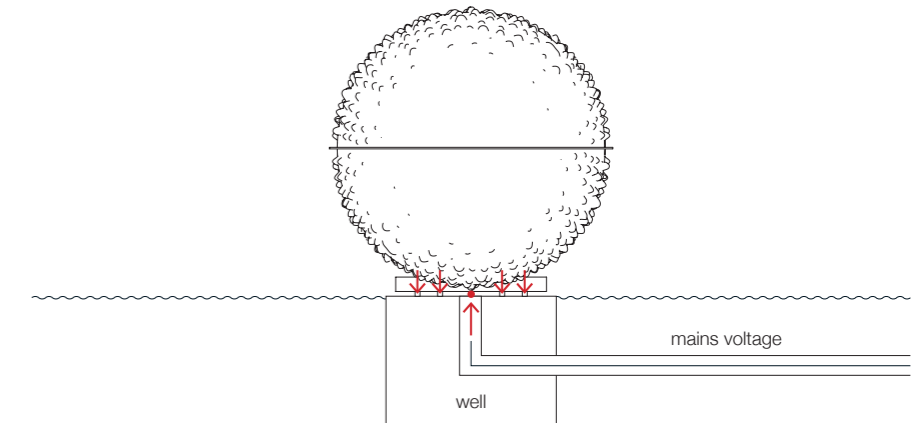
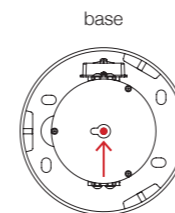

Example 3

with supporting plate 1x code MSM
with plug cable 230V 1x code MDCV

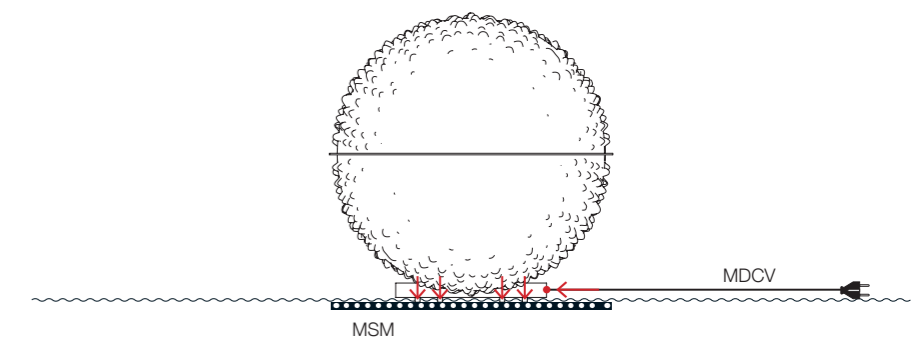
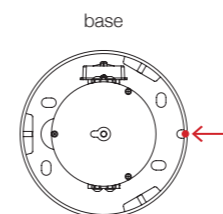

INSTALLATION SUGGESTIONS FOR SYPHASERA / SYPHASFERA / SYPHADUEPASSI / MORE

