

INSTALLATION GUIDE

Small Circular Ceiling Plate

Thoughtful lighting, responsibly designed in London.

Thank you for making the switch to Tala.
Discover the full Tala family at tala.co.uk

BEFORE STARTING

We advise the fitting of our ceiling rose and pendant to be performed by a qualified electrician. Please read through these instructions before commencing work, and keep them for future reference. Please take extreme care when carrying out these instructions.

IMPORTANT

This light fitting must be connected to the supply earth. If your lighting circuit does not have an earth, ask a qualified electrician to provide an earth facility. This light fitting is suitable for indoor use only. This fitting operates on 240V mains voltage. Please visit our website to see our recommended dimmers.

WARNING

Always switch off electricity supply at the mains during installation and maintenance. We recommend that the fuse is withdrawn or the circuit breaker is switched off whilst work is in progress. Do not just turn off at the wall switch. All fittings must be installed in accordance with current Building Regulations and IEE Wiring Regulations.

RECOMMENDED EQUIPMENT

- Small flat head screwdriver
 - Wire strippers
 - Insulation tape
 - M10 (17mm) (5/8IN) spanner or Adjustable spanner
- Further equipment may be required for fixing to your ceiling.

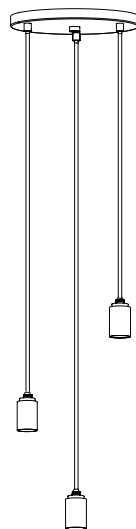
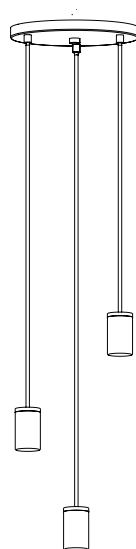

SKU - CP-WHT-SML-EU
SKU - CP-WHT-SML-WP-01-EU
SKU - CP-WHT-SML-OP-01-EU
SKU - CP-WHT-SML-GP-01-EU
SKU - CP-WHT-SML-BP-01-EU

SKU - CP-BLK-SML-EU
SKU - CP-BLK-SML-GP-01-EU
SKU - CP-BLK-SML-BP-01-EU
SKU - CP-BLK-SML-OP-01-EU
SKU - CP-BLK-SML-WP-01-EU



BASALT - 3 PENDANT SET - PROVIDED COMPONENTS

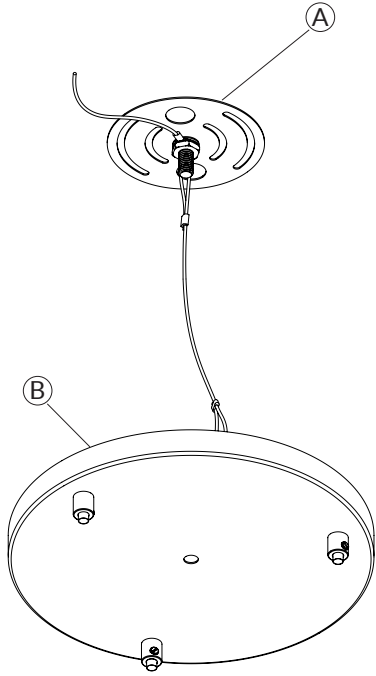

(A) x1 Ceiling Bracket

(B) x1 Ceiling plate

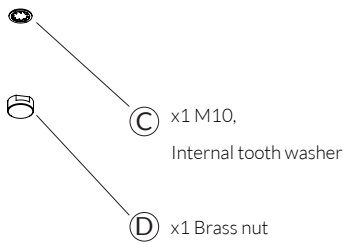

(C) x1 M10,
Internal tooth washer

(D) x1 Brass nut

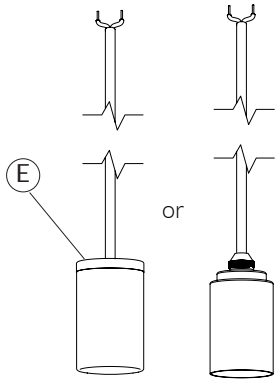

(E) x3 Tala Pendants
Oak, Walnut, Brass or Graphite

STEP 1

Attach (A) to the ceiling using screws and plug. Always choose screws and plugs that are appropriate for the ceiling.

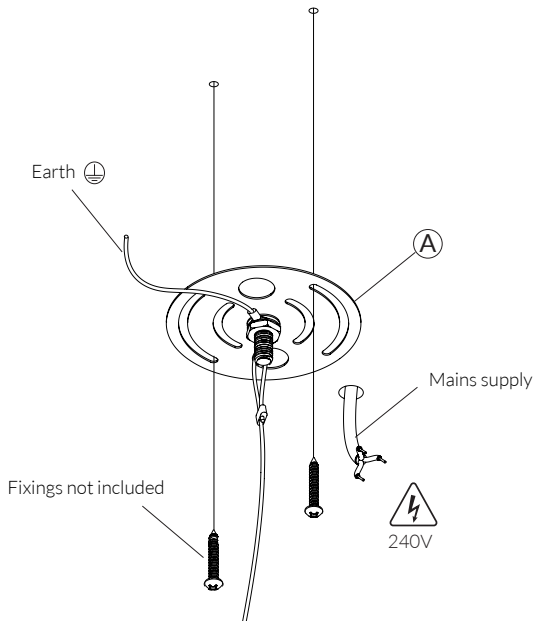

STEP 2

Thread all three pendant cables (E) through ceiling plate cord grips (B).

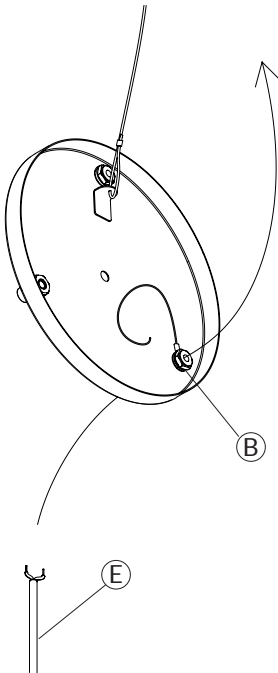

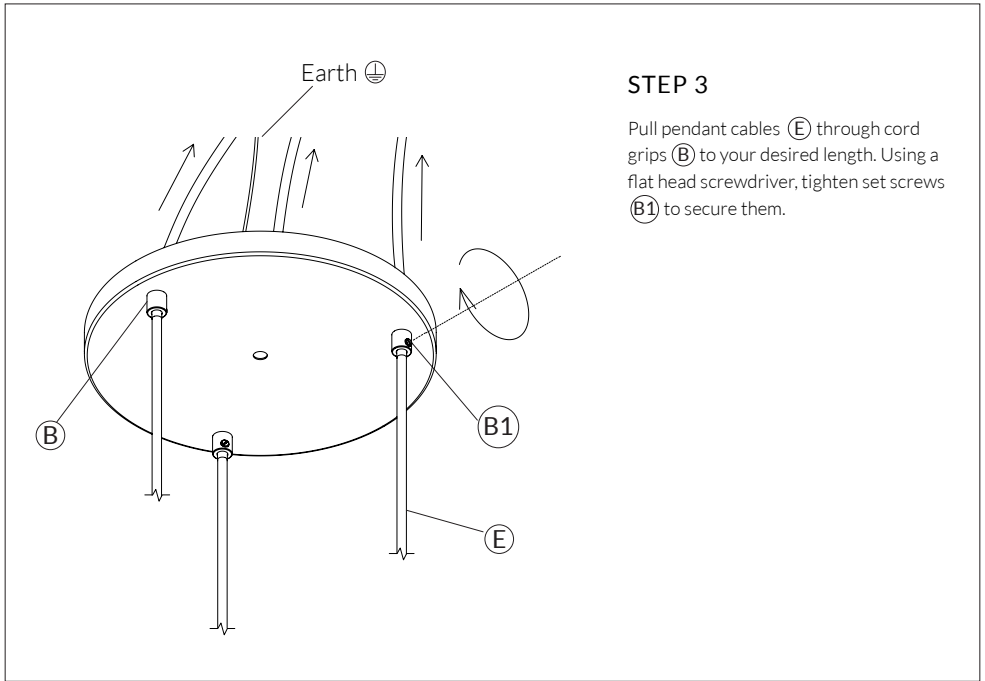

STEP 3

Pull pendant cables (E) through cord grips (B) to your desired length. Using a flat head screwdriver, tighten set screws (B1) to secure them.

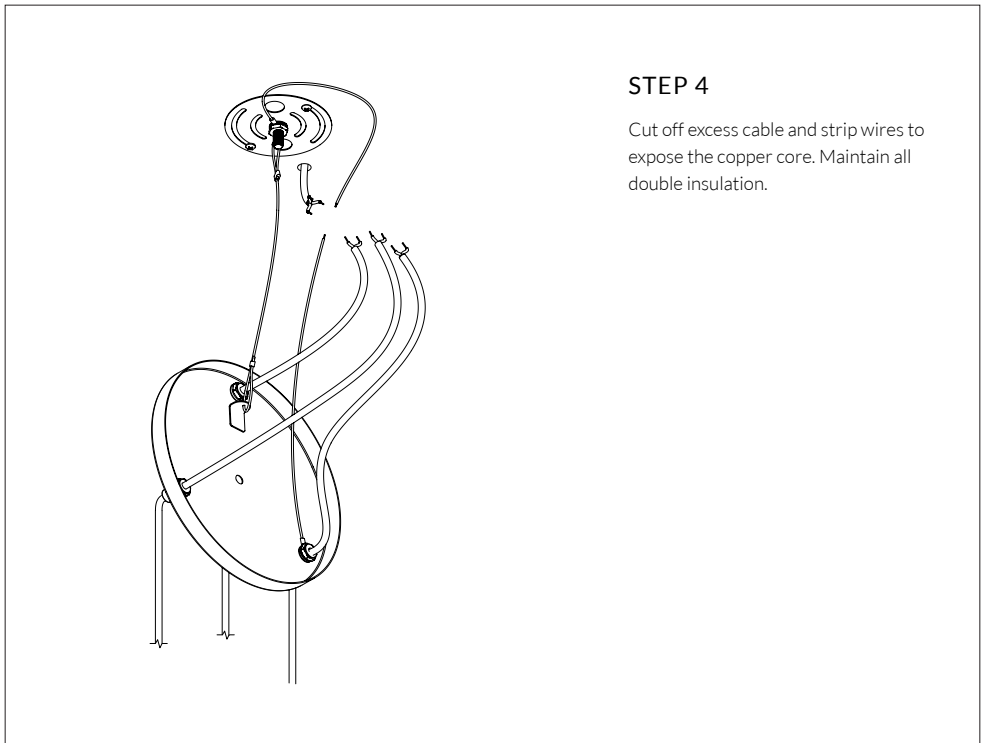

STEP 4

Cut off excess cable and strip wires to expose the copper core. Maintain all double insulation.

STEP 5

Connect the pendants, plate and mains wiring as shown.

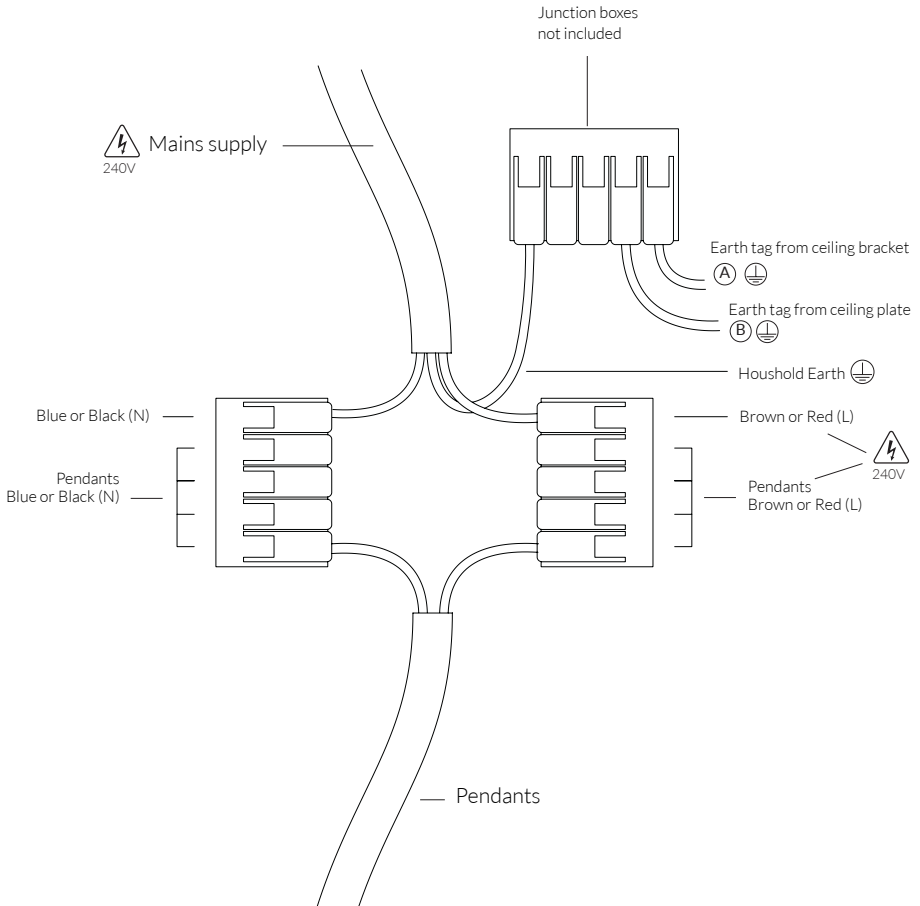

STEP 6

Move (B) up onto (A). Use toother washer (C) and nut (D) to secure it in place.

Do a final tighten with the correct spanner.

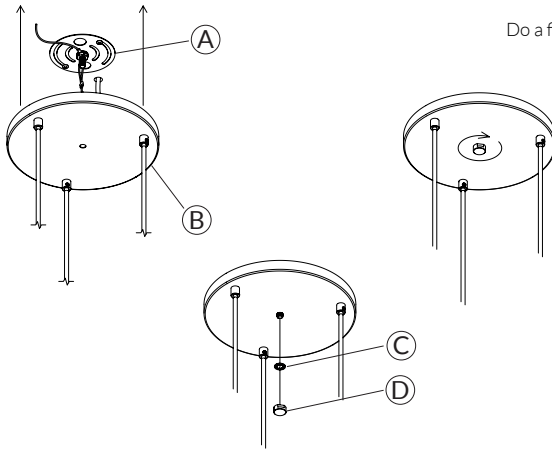

STEP 7

Screw bulbs into pendants (E) clockwise

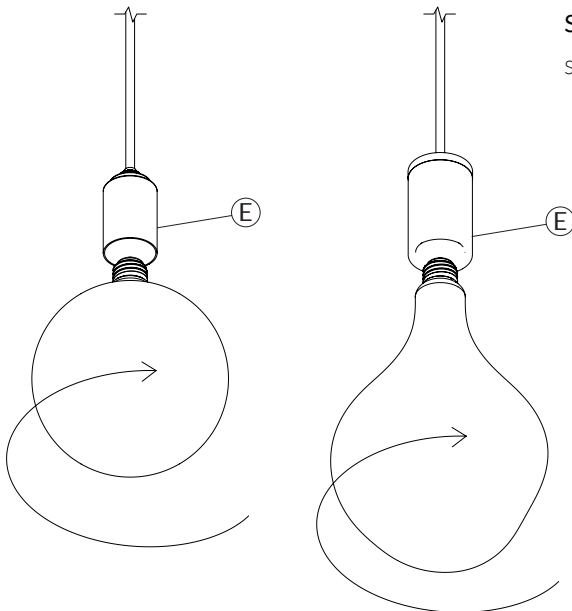

CARE AND CLEANING

We recommend cleaning with a soft dry cloth. Do not use abrasive materials as these will damage the finish of the product.

WARRANTY AND AFTER-CARE

This product has a three-year warranty. Within this time we will replace any parts that have functional defects.

Please report any faults by emailing:
customerservice@tala.co.uk

Join the Community

Instagram: @tala | Facebook: talaHQ | Pinterest: TalaLED | Tag: lighttoliveby
Tala Studios, 25B Vyner Street, London E2 9DG | +44 20 3026 3246 | hello@tala.co.uk